

Dimensions:	width	depth	height
inches	59"	29.5"	23.5"
mm	1500	750	600

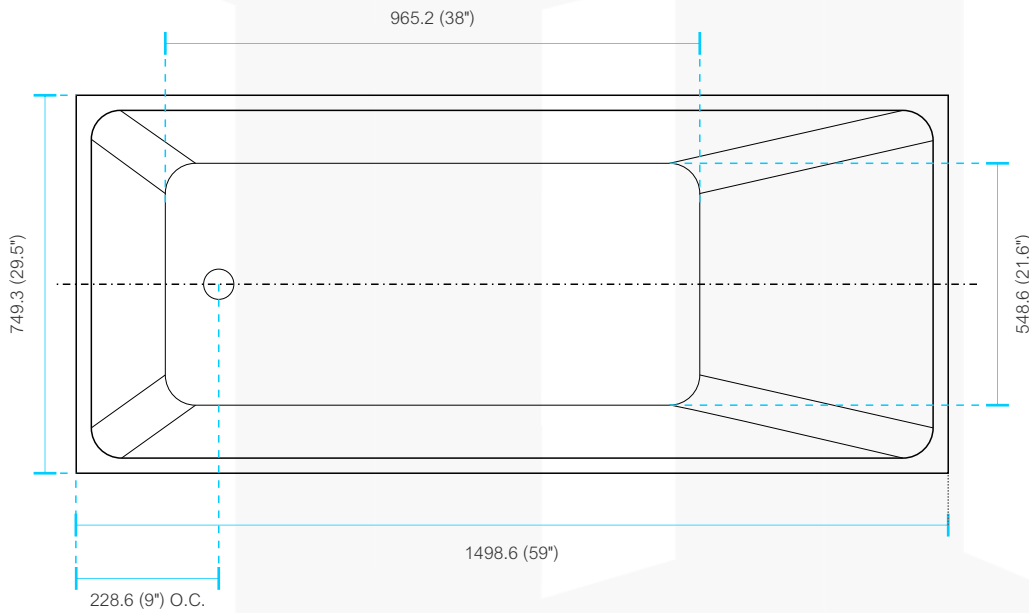

**Features:**

- . High molecular pure resin.
- . Warm to touch, easy to clean, won't fade, easy to repair.
- . High thermal water heat retention.
- . Level adjustment feet.
- . Brass Pop-up drain included.
- . Capacity: 51 Gallons.
- . cUPC Approved

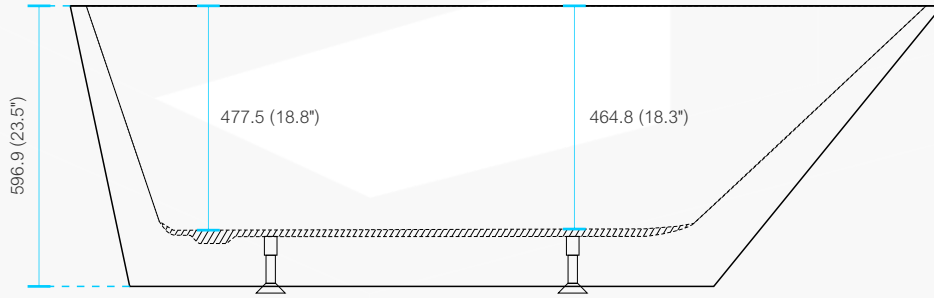