

SQUARE UNDERMOUNT SINK KB21

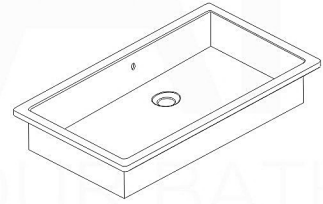

TOP ELEVATION

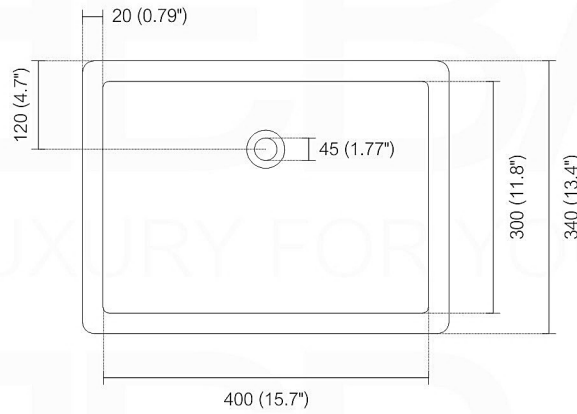

FRONT ELEVATION

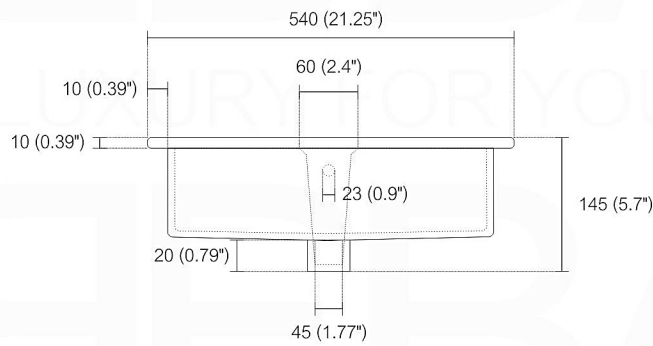

SIDE ELEVATION

